

Built to Last ■ Weather-Tight ■ Coil and Sheet ■ Roofer Ready



**Everlast Metals**

[everlastmetals.com](http://everlastmetals.com)





**Integrity. Performance. Value.**

Built on a foundation of uncompromising product quality, Everlast Metals is proud to be a leader in high-performing metal architectural roof and wall systems. By selecting Everlast Metals as your architectural systems provider, you are choosing an organization known for industry-leading structural and performance testing, commitment to continuous improvement and trend-setting science.

**Innovate. Create. Diversify.**

The creative options are endless when selecting Everlast Metals as your architectural roofing and wall systems partner. Your Everlast Metals colleagues are available to support you, whether it be for product consultation, take-off design or installation support: our commitment is to become an integral part of your team and help you succeed.

**Setting the bar for excellence.**

Everlast Metals understands the performance demands of your clients. Through our network of certified contractors, we offer a comprehensive selection of limited weathertightness warranties, providing you with another valuable service option for your clientele.

Servicing the architectural community for over a decade, Everlast Metals is proud of our reputation for uncompromising quality and is a logical choice for those looking for a true partner of architectural roof and wall systems.



*Scan QR code for Spanish version.*

*Escanea el código QR para la versión en español.*

# TABLE OF CONTENTS

## Metal Roof & Wall Panel Systems

Concealed Fastener.....4  
 Soffit & Wall.....8  
 Exposed Fastener.....14

## Color Selection

Concealed Fastener.....12  
 Exposed Fastener.....15





## SSL SERIES

The SSL-175 system is a high-performance, architectural/structural standing seam metal roof system available with customizable coverage. The panel features a snap-lock 1 3/4" seam height with minor ribs or striations available, and can accommodate up to 4" of blanket insulation.

Designed for structural performance, the SSL-175's snap-fit assembly eliminates the need for mechanical seaming or separate battens, and its optional factory-applied sealant bead provides an increase in weather resistance. Its 18-gauge concealed clip allows for unlimited thermal movement, adding to the integrity benefits of an aesthetically-appealing roof system.

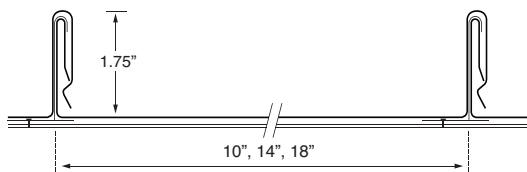

**SSL-175**

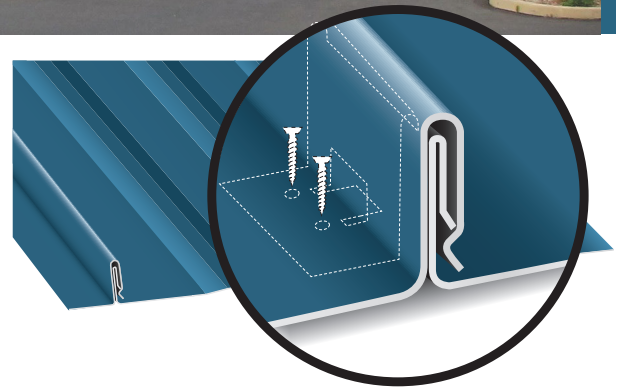

### Features and benefits:

- UL 90 rated per UL-580
- ASTM E283-91 air infiltration
- ASTM E330-90 structural performance
- ASTM E331-96 water penetration
- UL 2218 Class 4 Hail
- Stiffening ribs available
- Load/Span charts available

## NS SERIES



The NS Series is an economical, architectural, concealed-fastener roof system that may be used in a variety of applications. This series has the elegant look of a traditional architectural standing seam roof and may be manufactured with minor ribs or striations. Available in a 1" seam height, its clip-less system has a continuous fastening edge, allowing for quick installation and reduced labor costs.

The NS series is designed for solid substrate installation, and the absence of exposed fasteners and the water-tight side lap allows for applications on roof pitches as low as 3:12.

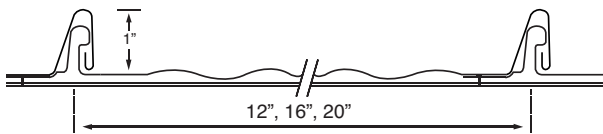

**NS-100**

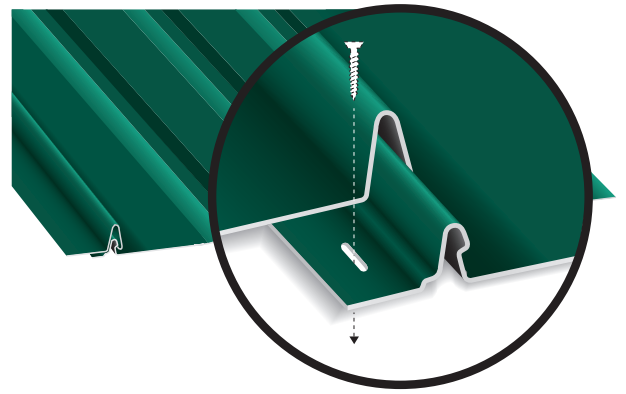

**UL 90  
RATED**

### Features and benefits:

- UL 90 rated per UL-580
- ASTM E283-91 air infiltration
- ASTM E330-90 structural performance
- ASTM E331-96 water penetration
- UL 2218 Class 4 Hail
- Stiffening ribs available
- Load/Span charts available

## ASL SERIES



The ASL Series is a standing seam roof system that offers the designer the classical look of a traditional standing seam panel and the high performance of an architectural system. This series offers a 1" or 1 1/2" seam height manufactured with optional minor ribs or striations, and its concealed clips allow for fluid thermal movement. It

is recommended that ASL Series panels are installed over a solid substrate with a minimum slope of 3:12.

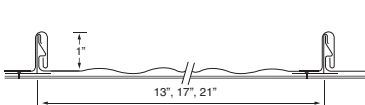

**ASL-100**

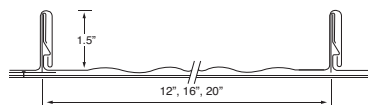

**ASL-150**

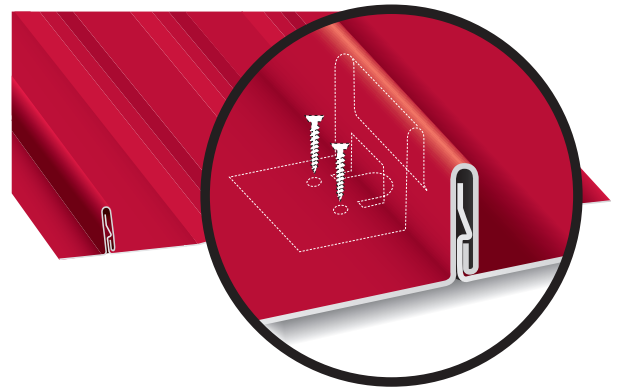

**UL 90  
RATED**

### Features and benefits:

- UL 90 rated per UL-580
- ASTM E283-91 air infiltration
- ASTM E330-90 structural performance
- ASTM E331-96 water penetration
- UL 2218 Class 4 Hail
- Stiffening ribs available
- Load/Span charts available

## DL SERIES



The DL Series 100 and 150 panels are a double-lock architectural standing seam system that provides a classical look that is supportive of more-rigorous wind-load designs required for many architectural projects. The 1" and 1 1/2" optional seam heights enable the panels to be curved with elective minor ribs or striations during Everlast Metals' industry-leading manufacturing process.

The DL Series features a factory-applied side lap sealant and concealed fasteners, allowing for fluid thermal movement. It is recommended that the DL Series is installed over a solid substrate with a minimum slope of 3:12 for the 1" optional seam height and a 1 1/2":12 slope for the optional 1 1/2" seam height.

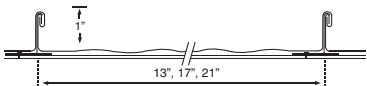

**DL-100**

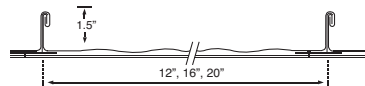

**DL-150**

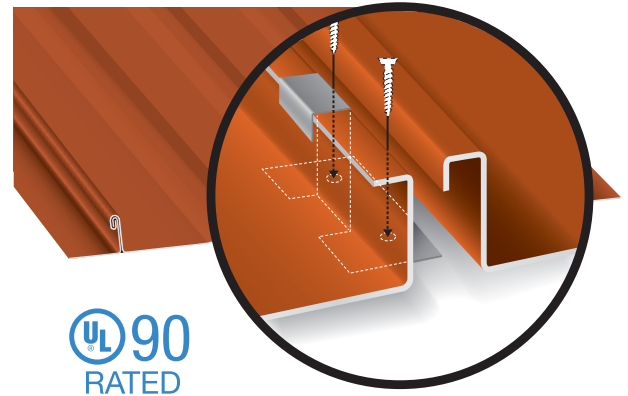

**UL 90  
RATED**

### Features and benefits:

- UL 90 rated in a wide variety of substrates
- ASTM E283-91 air infiltration
- ASTM E330-90 structural performance
- ASTM E331-96 water penetration
- ASTM E1646-95 water penetration
- ASTM E1680-95 air leakage
- ASTM E1592-98 uniform static air pressure
- UL 263 & UL 790 class A fire rating
- UL 2218 class 4 hail rating
- Load/Span charts available
- Available for radius applications

## DL-200



The DL-200 Panel is a double-lock architectural/ structural standing seam system that provides a classical standing seam look supportive of more-rigorous wind-load designs. The 2" seam height enables the panels to be structurally sound yet architecturally appealing, and its heavy-gauge concealed fasteners allows for maximum thermal

movement. The DL-200 Series offers optional weather tightness warranties and may be installed over open framing or solid substrates. It is recommended that the DL-200 series is installed with a minimum slope of 1:12.

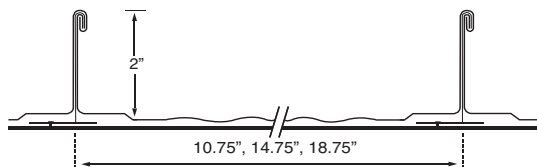

**DL-200**

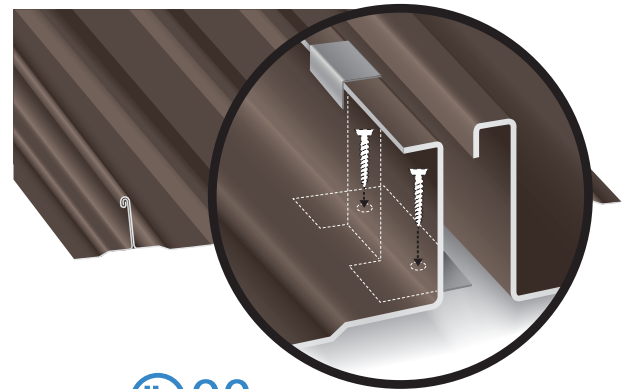

**UL 90  
RATED**

### Features and benefits:

- UL 90 rated per UL-580
- ASTM E1592-95 uniform static air
- ASTM E283-91 air infiltration
- ASTM E330-90 structural performance
- ASTM E331-96 water penetration
- UL 263, UL 790 class A fire tested
- UL 2218 class 4 hail tested
- Load/Span charts available



**Forks Township Fire Department**  
Easton, PA



# SOFFIT & WALL SYSTEMS



## W-LOC

The Everlast Metals W-LOC Soffit Panel is a v-groove panel available in a solid or vented profile. Application for use is endless but seen typically on porch ceilings, overhangs, and patios. W-LOC vented allows for 11% of net free area allowing for air circulation while decreasing condensation. The interlocking design of this system allows for quick installation.

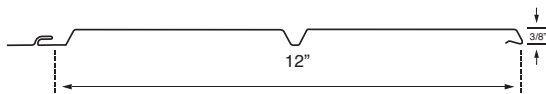

**W-LOC**

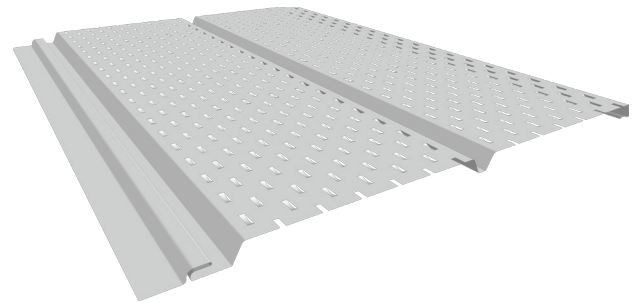

### Features and benefits:

- 35-Year finish warranty
- Minimum length of 8'
- Maximum length 25'
- Panel widths 12"

# FIDELITY® SERIES

The Everlast Metals Fidelity® Series is a set of concealed fastened metal wall panels, each with unique angles and rib patterns which can be combined to create an individualized style. Can be installed in a vertical or horizontal wall application. Ideal for fascia and equipment screen applications as well.



**FL-550**



**FL-850**



**FL-550**



**FL-850**

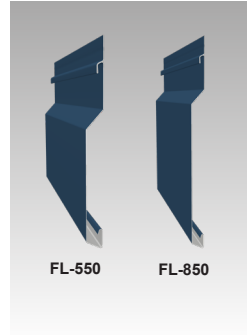

**FL-550**

**FL-850**

# TETRA®

The Everlast Metals Tetra® is a concealed fastened metal wall panel, with unique angles and rib patterns which can be combined to create an individualized style. Can be installed in a vertical or horizontal wall application. Ideal for fascia and equipment screen applications as well.



ALTERNATE HEM FOR  
DECREASE COIL WIDTH  
1-3/4" (44.5mm)



**Tetra®**



**Tetra®**

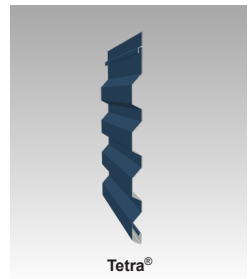

**Tetra®**

## Features and benefits:

- 35-Year finish warranty
- Minimum length 2'
- Max length 40'
- FL-550 panel width 8"
- FL-850 panel width 12"
- Tetra® panel width 16"
- ASTM E283 air infiltration
- ASTM E331 water infiltration
- Recommended for application over solid framing



**Everlast Metals Corporate Office**  
Lebanon, PA

**The Greenery Apartments**

Philadelphia, PA





The Everlast Metals RP-100 and FP-100 Panel Systems provide versatility for use as both soffit and wall applications. Wall panels are available with optional minor ribs and striations, and soffit panels offer v-grooves, available with or without ventilation. The RP-100 and FP-100 hidden fastener systems creates the look of a flush application appearance, and optional factory-applied sealant provides increased weather tolerance.

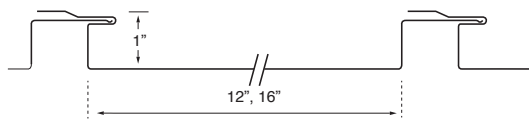

**RP-100**

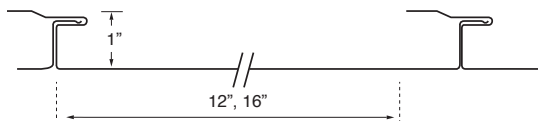

**FP-100**

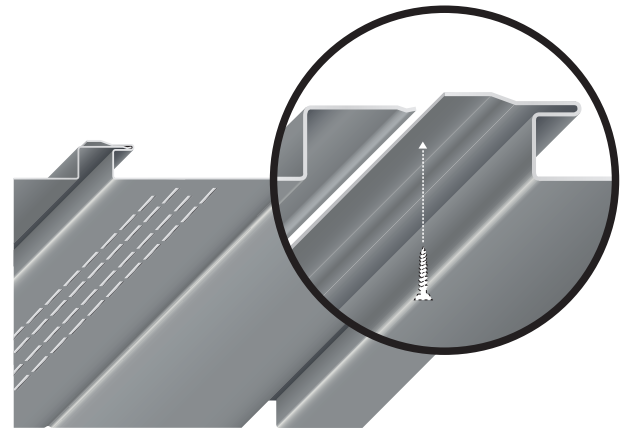

**REVEAL PANEL**

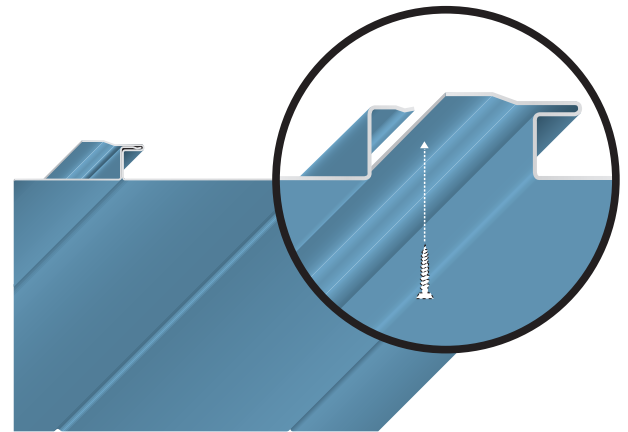

**FLUSH PANEL**

**Features and benefits:**

- UL 263, UL 790 class A fire tested
- UL 2218 class 4 hail tested
- Architectural embossed patterns
- Stiffening ribs available
- Factory-applied sealant
- Vented profile



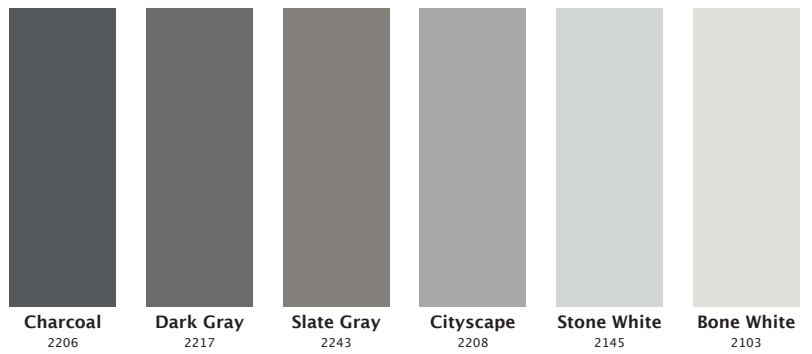
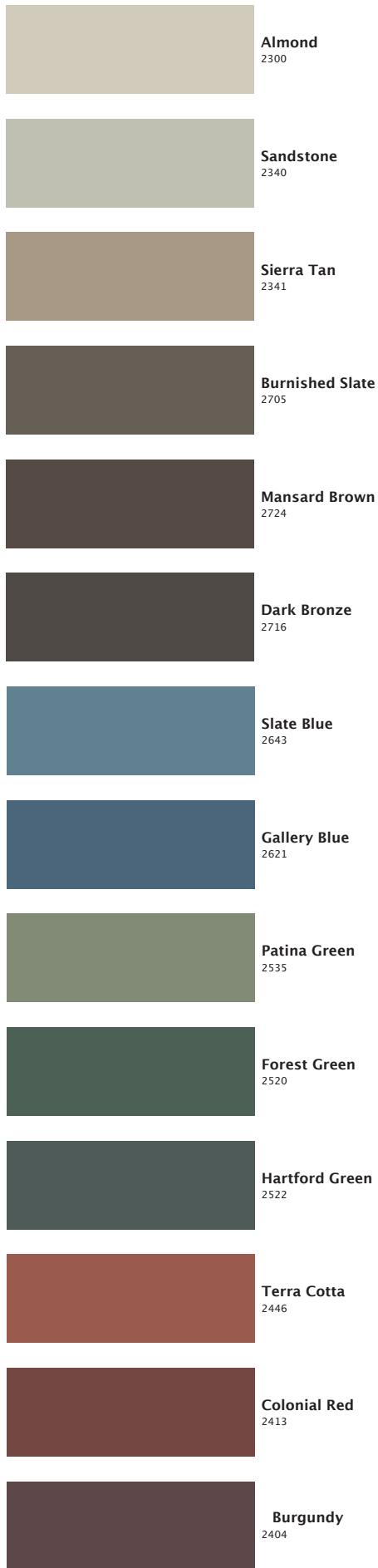

# Everlast Metals

## Fluoropon® Color Guide



Colors marked with an dot ( \* ) are Premium Colors.

**PLEASE NOTE:** The colors listed on this color chart are as close to the actual painted metal as possible. Actual color swatches are available upon request.

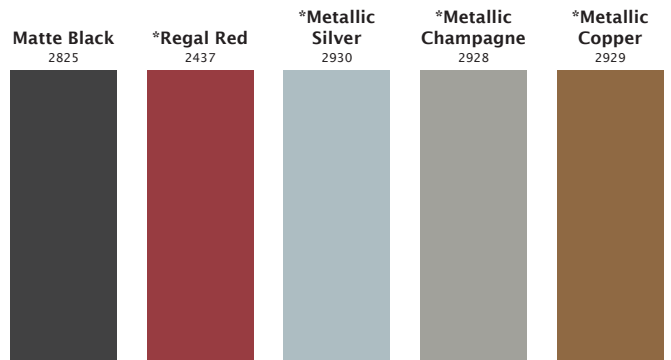

# Everlast Metals

800.418.5057

EVERLASTMETALS.COM

FLUOROPON® PAINT SYSTEM	STEEL	ALUMINUM		TECHNICAL DATA							
		24 GA.	0.032	0.040	LEED®	INITIAL TSR	INITIAL TE	INITIAL SRI	3 YEAR TSR	3 YEAR TE	3 YEAR SRI
STANDARD FINISH - 35 YEAR WARRANTY											
Almond	•	•		•	0.56	0.83	65	0.65	0.83	77	
Bone White	•	•	•	•	0.67	0.87	81	0.64	0.87	77	
Burgundy	•	•			0.26	0.87	25	0.26	0.87	25	
Burnished Slate	•	•	•	•	0.31	0.87	32	0.32	0.87	33	
Charcoal	•	•	•		0.27	0.87	27	0.28	0.87	27	
Cityscape	•	•	•	•	0.38	0.87	42	0.39	0.87	30	
Colonial Red	•	•	•	•	0.29	0.83	30	0.29	0.88	30	
Dark Bronze	•	•		•	0.29	0.88	30	0.30	0.88	30	
Dark Gray	•	•	•	•	0.34	0.88	36	0.34	0.88	36	
Forest Green	•	•	•	•	0.32	0.88	33	0.32	0.87	33	
Gallery Blue	•	•	•	•	0.30	0.87	31	0.30	0.87	31	
Hartford Green	•	•	•	•	0.29	0.87	30	0.29	0.88	30	
Mansard Brown	•	•	•	•	0.28	0.88	29	0.29	0.89	30	
Matte Black	•	•	•	•	0.26	0.89	25	0.26	0.87	25	
Patina Green	•	•	•	•	0.28	0.87	29	0.28	0.89	29	
Sandstone	•	•	•	•	0.40	0.89	44	0.40	0.87	44	
Sierra Tan	•	•	•	•	0.54	0.87	63	0.53	0.87	62	
Slate Blue	•			•	0.52	0.87	60	0.51	0.87	59	
Slate Gray	•	•	•	•	0.34	0.88	36	0.34	0.88	36	
Stone White	•			•	0.43	0.87	48	0.43	0.87	48	
Terra Cotta	•			•	0.62	0.88	74	0.59	0.88	70	
Galvanized G90 - Acrylic Coated	•										
Galvalume® AZ55 - Acrylic Coated	•										
Mill Finish		•	•								
PREMIUM FINISH - 35 YEAR WARRANTY											
Regal Red	•	•		•	0.49	0.88	56	0.49	0.88	56	
Metallic Champagne	•			•	0.41	0.87	46	0.38	0.91	43	
Metallic Copper	•	•		•	0.37	0.87	41	0.43	0.90	50	
Metallic Silver	•	•		•	0.54	0.87	64	0.46	0.91	53	

POLYESTER PAINT SYSTEM	STEEL	ALUMINUM	
STANDARD FINISH - 35 YEAR WARRANTY	24 GA.	0.032	0.040
Bronze/White		•	
Medium Bronze/Bronze		•	
Black/White		•	
White/White		•	

- Oil canning is not a cause for rejection.
- Protective film must be removed immediately after installation.
- For a true color representation, please call or write for actual metal sample(s).
- Contact your local sales representative for specific stocking information and special requests.

# EXPOSED FASTENER PANELS

## OMNI



The Everlast Metals OMNI Series is 38" wide and provides 36" of coverage. The major ribs are 9" apart and approximately 3/4" high with two minor ribs in between that are a full 3/16" high. A stiffener is added to all the major ribs, which, along with the superior thickness of the steel, makes this panel extremely strong. This not only adds considerable durability to your building, but also prevents rippling during the construction process.

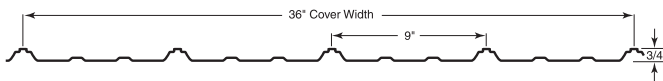

OMNI

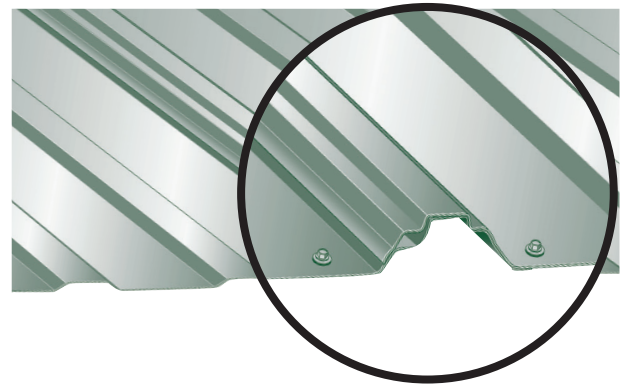

### Features and benefits:

- Next Generation AZM® Rust Resistance
- Synergy™ Fade and Chalk Resistance
- Panels made using exclusive Evercure Process with Heat Forming
- Industry Leading Packaging
- 50-Year finish warranty
- Exposed fastener system
- Panel width 36"
- Minimum slope requirement 3:12
- Board and batten look
- 28-gauge (.0162) Structural Steel Grade 80

## PBR



The Everlast Metals PBR Panel is designed for both roofing and siding applications. This panel is excellent for most any exterior use, including industrial, commercial and agricultural applications. The PBR Panel can also be used as an interior liner panel.

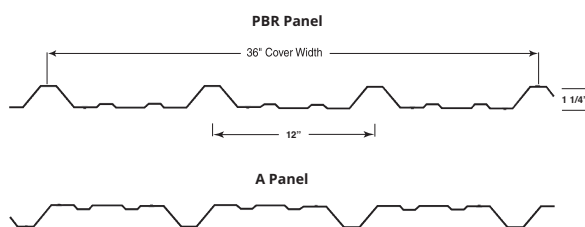

PBR

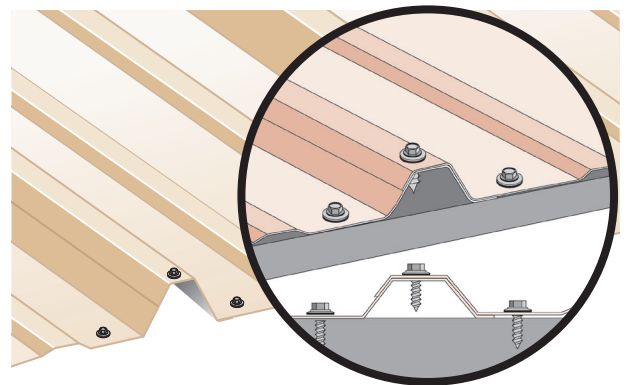

### Features and benefits:

- 26-gauge Structural Steel Grade 80 (Synergy™ paint system)
- 40 year warranty for Synergy™ finish
- 24-gauge Structural Steel Grade 50 (Fluropon® paint system)
- 35 year warranty for Fluropon® finish
- Fluropon® Chalk & Fade Resistance
- Minimum length of 36"
- Watertight side lap
- Minimum slope requirement 1:12
- Panel width 36"

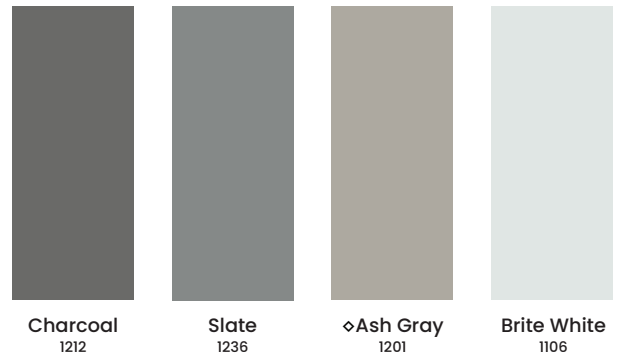
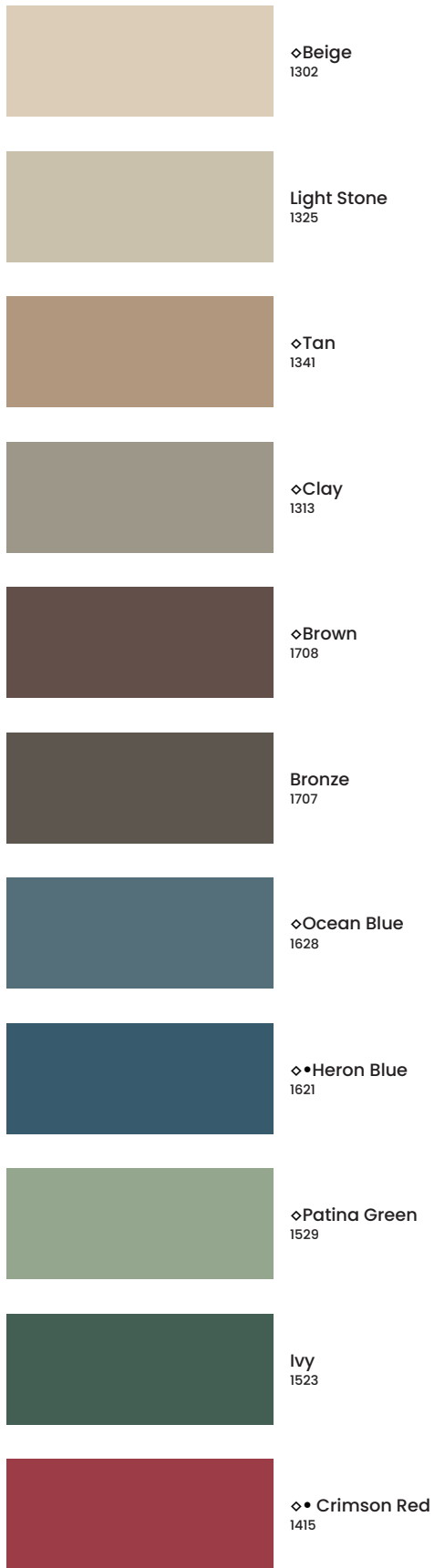

# Everlast Metals

## Synergy™ Color Guide



Colors marked with a dot ( • ) are Premium colors.

Colors marked with a diamond ( ◇ ) are subject to extended lead times for 26 gauge material.

Colors marked with an asterisk ( \* ) are only available in 28 gauge material.

**PLEASE NOTE:** The colors listed on this color chart are as close to the actual painted metal as possible. Actual color swatches are available upon request.

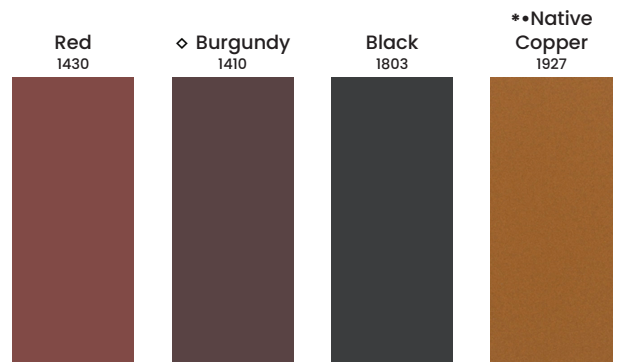

**///Everlast Metals**

[everlastmetals.com](http://everlastmetals.com)

Corporate Office  
10 Enterprise Court Lebanon, PA 17042  
Toll Free Phone: (800) 418-5057  
Local: (717) 389-0234